

 **Doric FPD**
Food Packaging and Decoration

 **Doric Crimped**
Paper Case Manufacturers

Sugarfayre

CULPITT



Cake Decorations & Food Packaging



Cake decorations and food packaging

Quality and consistency guaranteed



- ✓ **Market leaders**
- ✓ **Fast turnaround**
- ✓ **Short lead times**
- ✓ **Made in the UK**
- ✓ **BRCGS accredited sites**
- ✓ **Own label development**
- ✓ **Wholesale**
- ✓ **Fast shipping**
- ✓ **Worldwide delivery**
- ✓ **Friendly Customer Service**
- ✓ **Expert Advice**
- ✓ **Great Value**

Sugarfayre, Doric and Culpitt are market leading UK suppliers of sweet and savoury food packaging and cake decorating components to the food service industry.

With capability spanning the production of edible cake decorations, cake boards, insert cards, trays, greaseproof paper, baking cases, tin liners and beyond, we meet the needs of customers of all sizes from our UK sites, and distribute globally.

Specialising in manufacturing both own label and branded products, we supply direct to food producers and retailers at the best prices, on time and on budget. We also wholesale a wide range of off-the-shelf options.

If you have a food packaging or cake decorating need (or both!), we have a solution. Dedicated to providing friendly, efficient and collaborative customer service, we'll work with you to achieve the best option for your finished food product. From simple functional card inserts that need to protect, to innovative eye-catching cupcakes with shelf popping appeal, talk to us today!



Who we are



- Edible Decorations
- Printed Sugar
- Sweetmelts®
- Rotary Moulded
- Sugar Sheets
- Wafer



- Baking Cases
- Liners



- Cake Boards and Drums
- Food Packaging



- Wholesale Cake Decorations
- Wholesale Cake Packaging



SUGARFAYRE

- SWEETMELTS®
- PRINTED SUGAR
- ROTARY MOULDED
- WAFER
- SUGAR PASTE SHEETS
- HAND FINISHING

Sugarfayre is a leading UK manufacturer of bespoke edible decorations for celebration cakes, cupcakes, doughnuts, home baking kits and any other sweet treats.

Working collaboratively with customers, we specialise in cost effective, high impact pick-and-place decorations that add more value making your finished bake more profitable.

Our expertise ranges from printed sugar and wafer to rotary moulding and Sweetmelts®. We also produce blank sugar sheets for any print-on-demand systems, including PhotoCake®.

Our decorations dominate the supermarket cake aisle on private label and licensed character celebration cakes. You'll find them in home baking kits and on products such as doughnuts and cupcakes in high street outlets, cafes and coffee shops.

We have short lead times and low MOQs, so talk to us about your specific decoration brief today. We'll work with you to create consistently great looking cakes everyday, for any occasion.



PRINTED SUGAR



SWEETMELTS®



WAFER



ROTARY MOULDED



SUGAR PASTE SHEETS

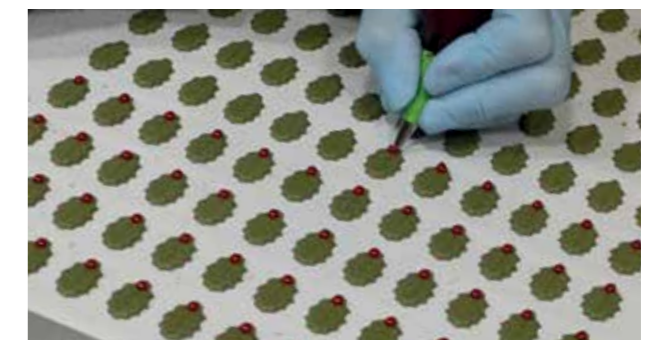

HAND FINISHING



Sugarfayre Limited, Unit 2 Wansbeck Business Centre, Rotary Parkway, Ashington, Northumberland, NE63 8QW

T: +44 (0)1670 814 545 E: sales@sugarfayre.net

www.sugarfayre.net

Company Number: 02656629 VAT: 556 1355 41 EORI: GB556135541000

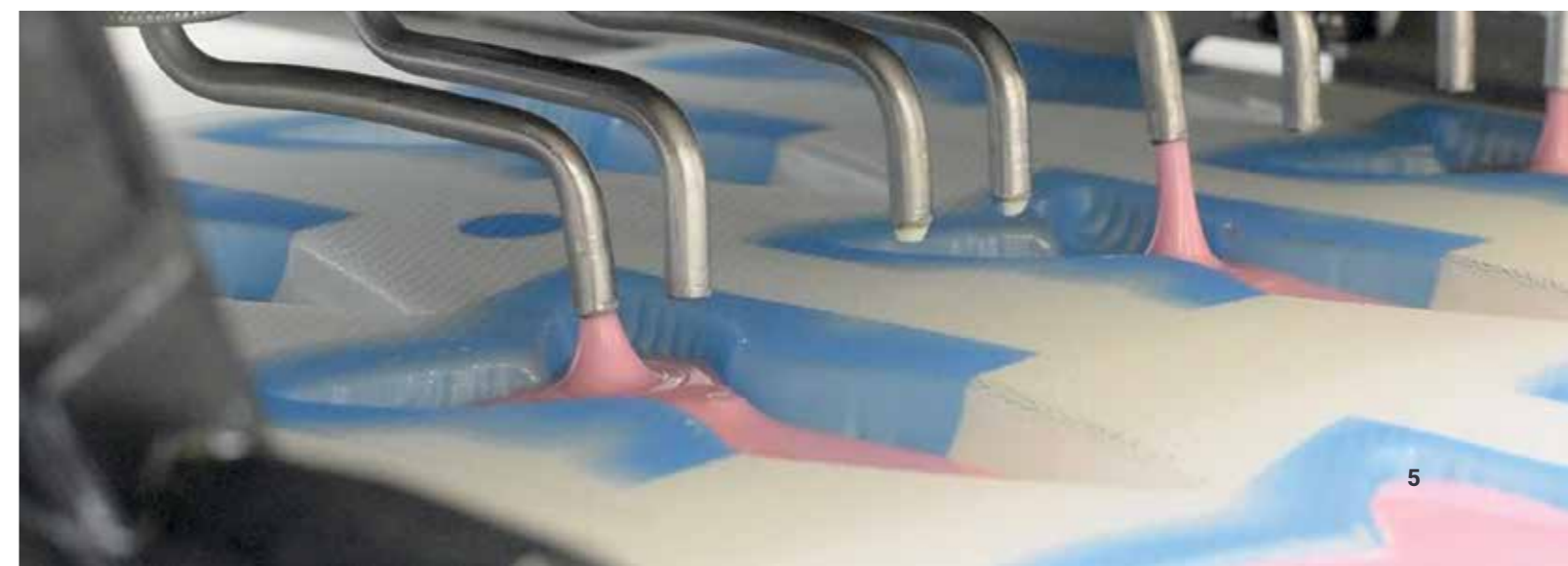

Printed Sugar



Printed sugar decorations are made from flat sugar paste sheet. They are printed and cut out ready to be applied to the tops or sides of cakes of all sizes from individual cupcakes, doughnuts or gingerbreads, to complete celebration cakes.



Printed sugar is a cost effective way to deliver high value cake decoration



What's possible?

- ✓ Characters, sentiments and logos
- ✓ Bespoke shapes and designs
- ✓ Bright and vibrant CMYK print
- ✓ Spot colours matched to pantones
- ✓ Low sugar options
- ✓ Embossed finish / glazed finish
- ✓ Natural colours
- ✓ Metallics / E171 free
- ✓ FDA colours available
- ✓ RSPO Sustainable Palm
- ✓ Vegetarian / Vegan / Gluten Free
- ✓ Consumer packaged options



Printed Sugar Tools

Printed sugar can be made in any shape required, or choose from our range of standard shapes and sizes for the most cost-effective decorations. This is just a small selection of our most popular customer favourites:

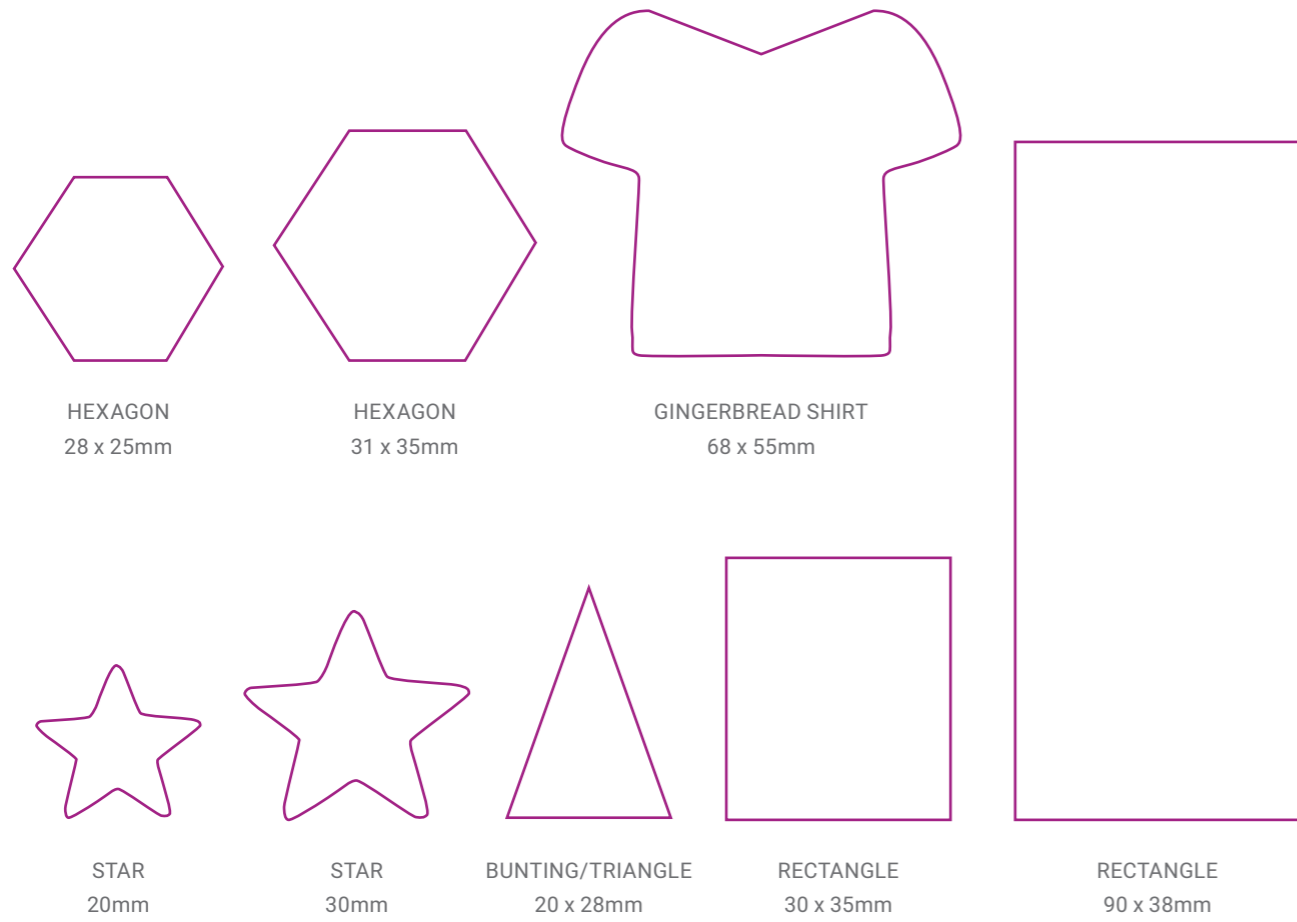

Speak to us to see the full range and discuss custom shapes and sizes

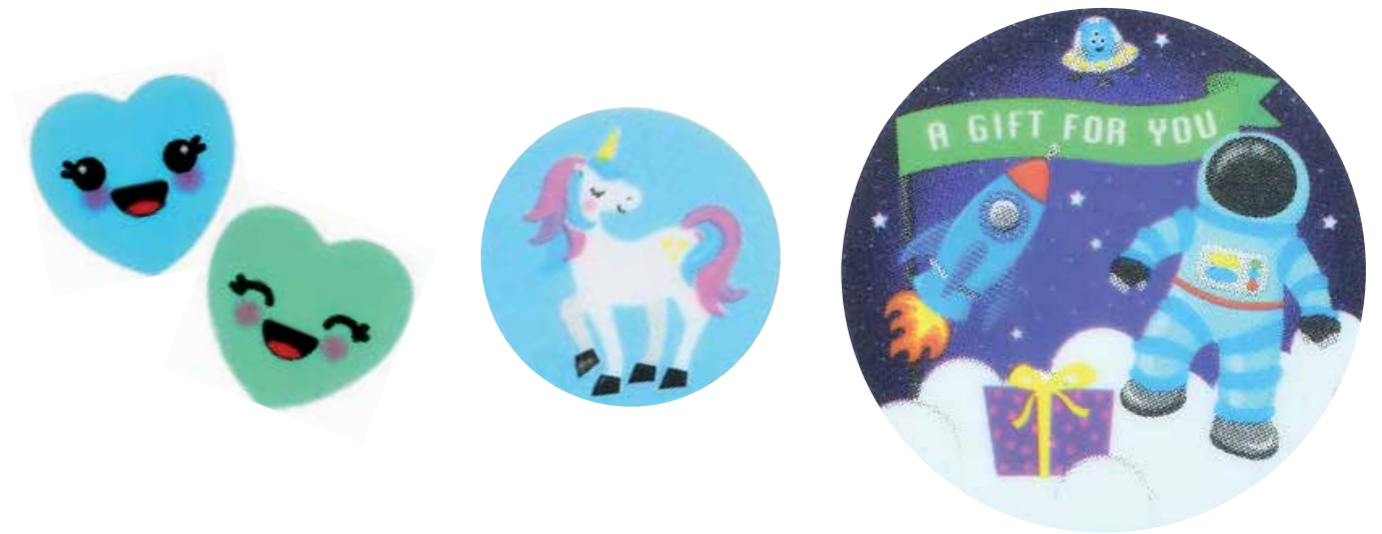

Sweetmelts®



Sweetmelts® are premium white chocolate flavoured compound decorations that can have a printed surface. The luxurious half relief structure makes it a popular choice for the best quality cakes. Impressive print and colour reproduction maximises impact on shelf whilst still delivering exceptional value for money.



High impact shelf appeal

What's possible?

- ✓ Characters, sentiments, themes and logos
- ✓ Bright and vibrant CMYK print
- ✓ Spot colours matched to pantones
- ✓ Bespoke shapes and designs
- ✓ Solid coloured compound
- ✓ Requires temperature controlled storage until application
- ✓ Gluten Free

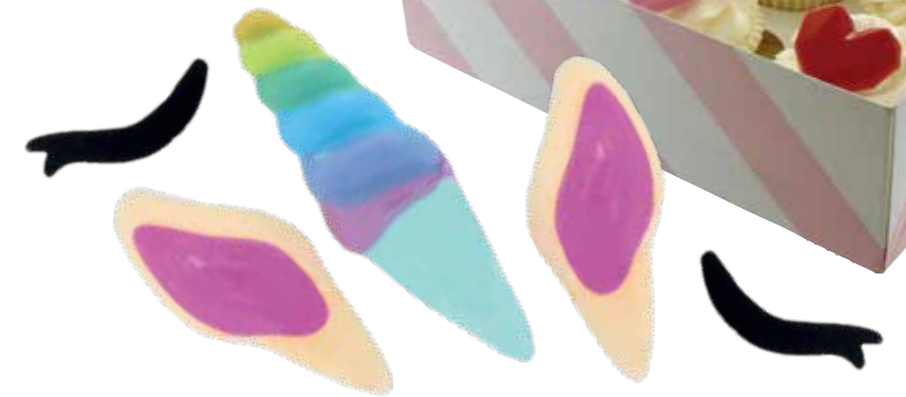

Rich white chocolate flavour decoration



Rotary



Rotary decorations are simple single colour shapes made from coloured sugar paste. They are produced in large volumes to give consistent, identical results. Often embossed during production, rotary decorations can be embellished with additional hand finished iced details or lustre sprays.

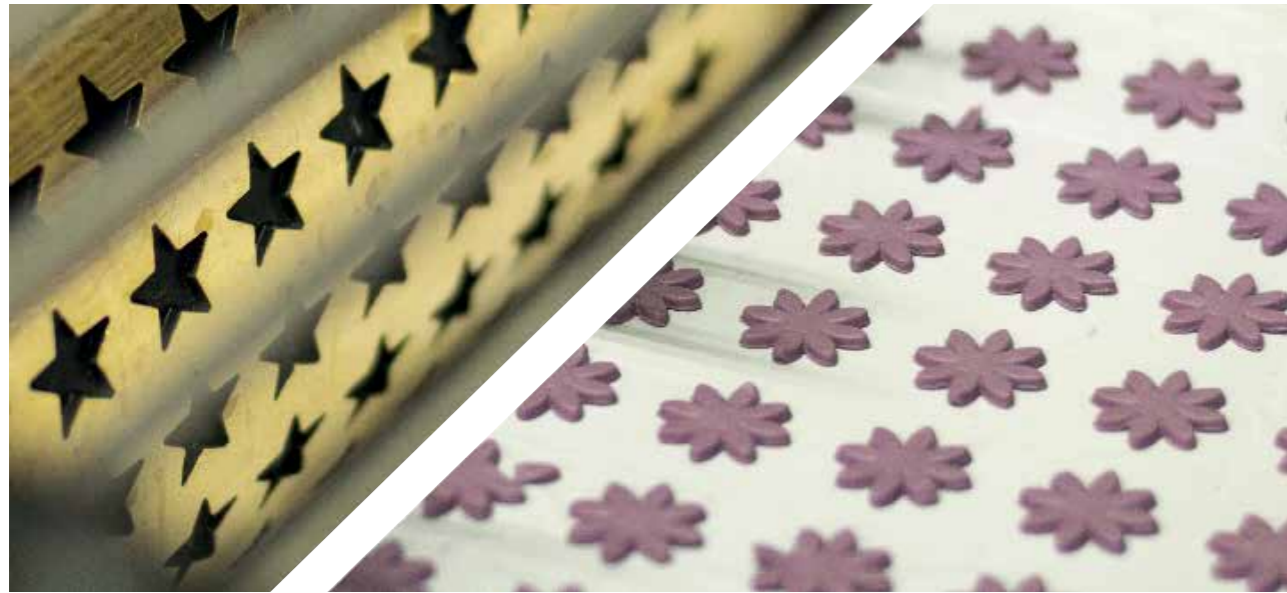

What's possible?

- ✓ Simple solid single colour shapes
- ✓ Flat or formed
- ✓ Texture detail
- ✓ Spray finish including metallics
- ✓ Hand piped finish
- ✓ RSP0 Sustainable Palm
- ✓ Vegetarian / Vegan / Gluten Free



High impact simplicity



Rotary Tools

Rotary tools can be made in any shape required, or choose from our range of standard shapes and sizes for the most cost-effective decorations. This is just a small selection of our most popular customer favourites.

Speak to us to see the full range and discuss custom shapes and sizes



DAISY
20mm

FLOWER
26mm

DAFFODIL
38 x 40mm

3 LEAF HOLLY
56 x 50mm

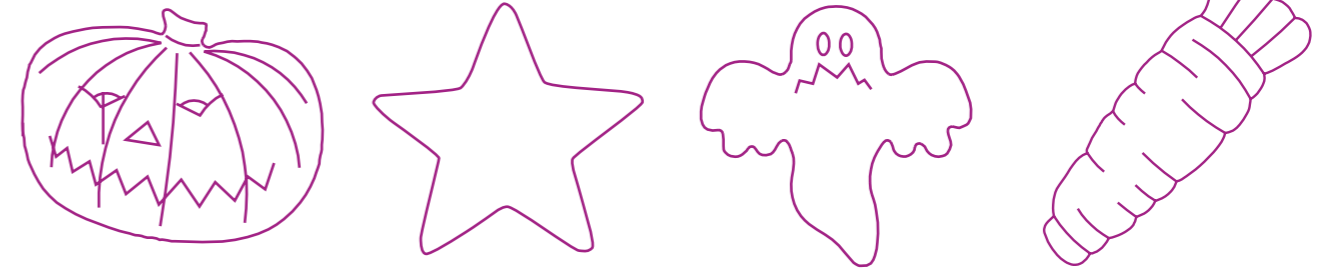

PUMPKIN
23 x 17mm

STAR
26 x 25mm

GHOST
26 x 25mm

CARROT
38 x 12mm

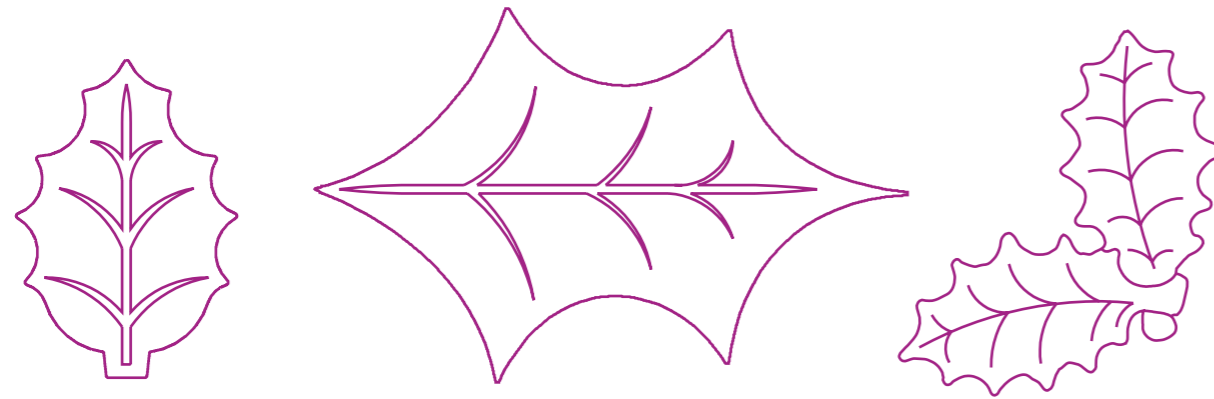

HOLLY STEM
34 x 26mm

6 POINT HOLLY
45 x 72mm

2 LEAF HOLLY
50 x 28mm

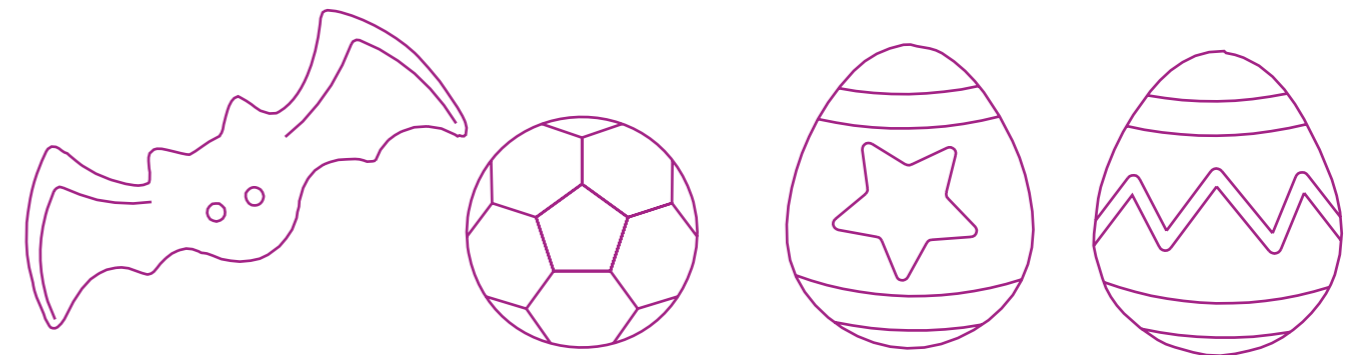

BAT
36 x 15mm

FOOTBALL
20mm

STAR EASTER EGG
36 x 15mm

EASTER EGG
36 x 15mm



Wafer



Wafer is a popular low cost, low sugar, low fat decoration option. It is often used for smaller sized decorations for individual cakes or used as a component on larger cakes. Frequently used in character cake decorating kits, wafer decorations are lightweight and can also be simply flow wrapped in a consumer-friendly sheet.



What's possible?

- ✓ Characters, sentiments, themes & logos
- ✓ Standard round and hexagon shapes
- ✓ Bespoke shapes and designs
- ✓ CMYK print
- ✓ Spot colours matched to pantones
- ✓ Low sugar / low fat
- ✓ Vegetarian / Vegan / Gluten Free
- ✓ Consumer packaged options



Sugar Paste Sheets



Plain white sugar paste sheets are for end user printing on demand using edible ink printers. It's the same top quality sugar paste that is produced in house and rolled into thin sheets that we use for our finished decorations. Print-on-demand sheets are backed with paper and supplied in bulk for customers to create unique and personalised cake decorations using their own designs and printers, at their own manufacturing sites. Produced as complete sheets, strips or rounds they can be used to decorate the tops and sides of cakes, individual cupcakes, biscuits, donuts, slices and more.

Precision thickness



DIY print on demand



What's possible?

- ✓ White sugar paste fondant rolled 0.7mm to 1.4mm thick
- ✓ Full sheets up to A3
- ✓ Sheets of circles, squares and rectangles
- ✓ Make your own cake toppers and cake collars
- ✓ Low sugar options
- ✓ Vegetarian / Vegan / Gluten Free
- ✓ RSPO Sustainable Palm
- ✓ Paper-backed sheets for easy printer processing, peel and place
- ✓ Complete personalisation opportunities
- ✓ You create and control the finished designs
- ✓ You print decorations in the volumes you need, when you need them

Create your own edible cake decorations using fondant sheets



DORIC CRIMPED

- BAKING CASES
- CAKE TIN LINERS
- AIR FRYER LINERS
- LOAF TIN LINERS
- PRINTED TIN LINERS
- HOT FOOD LINERS
- PRINTED GREASEPROOF SHEETS
- TULIP CASES
- PATISSERIE CASES

Doric Crimped is a market leading manufacturer of top-quality baking cases and liners for the food industry with over 50 years' experience.

Producing over 1 billion crimped items in the UK every year, our expertise covers a wide range of shapes and sizes of packaging for sweet or savoury food. They are suitable for the oven, air fryer, microwave or freezer.

We only use the best quality greaseproof, siliconised paper or foil, and water-based food safe ink is used for all printing. Doric Crimped is proud to be FSC® Chain of Custody certified, please speak to us about your specific requirements.

Production methods vary depending on volumes and design, so we'll work with you to create your perfect case whether it's a practical time saving liner to simplify mass production, or a stand-out consumer packaged cupcake case to meet home baking demand. Talk to us about your brief today!



BAKING CASES



CAKE TIN LINERS



AIR FRYER LINERS



LOAF TIN LINERS



PRINTED TIN LINERS



PATISSERIE CASES



Doric Crimped, Bowden Park, Chapel-en-le-Frith, High Peak, Derbyshire, SK23 0JX
 T: +44 (0)1298 812 181 E: info@doriccrimped.co.uk
 www.doriccrimped.co.uk
 Company Number: 7404814 VAT: 104906632 EORI: GB104906632000

Baking Cases



The standard core range consists of 5 sizes of round greaseproof paper cases. These are the most popular industry-standard baking cases and generally meet most customer needs: Petit Four, Mini Muffin, Fairy, Cupcake and Muffin. A wide range of other sizes are available and custom tooling is also possible for bespoke sizes.

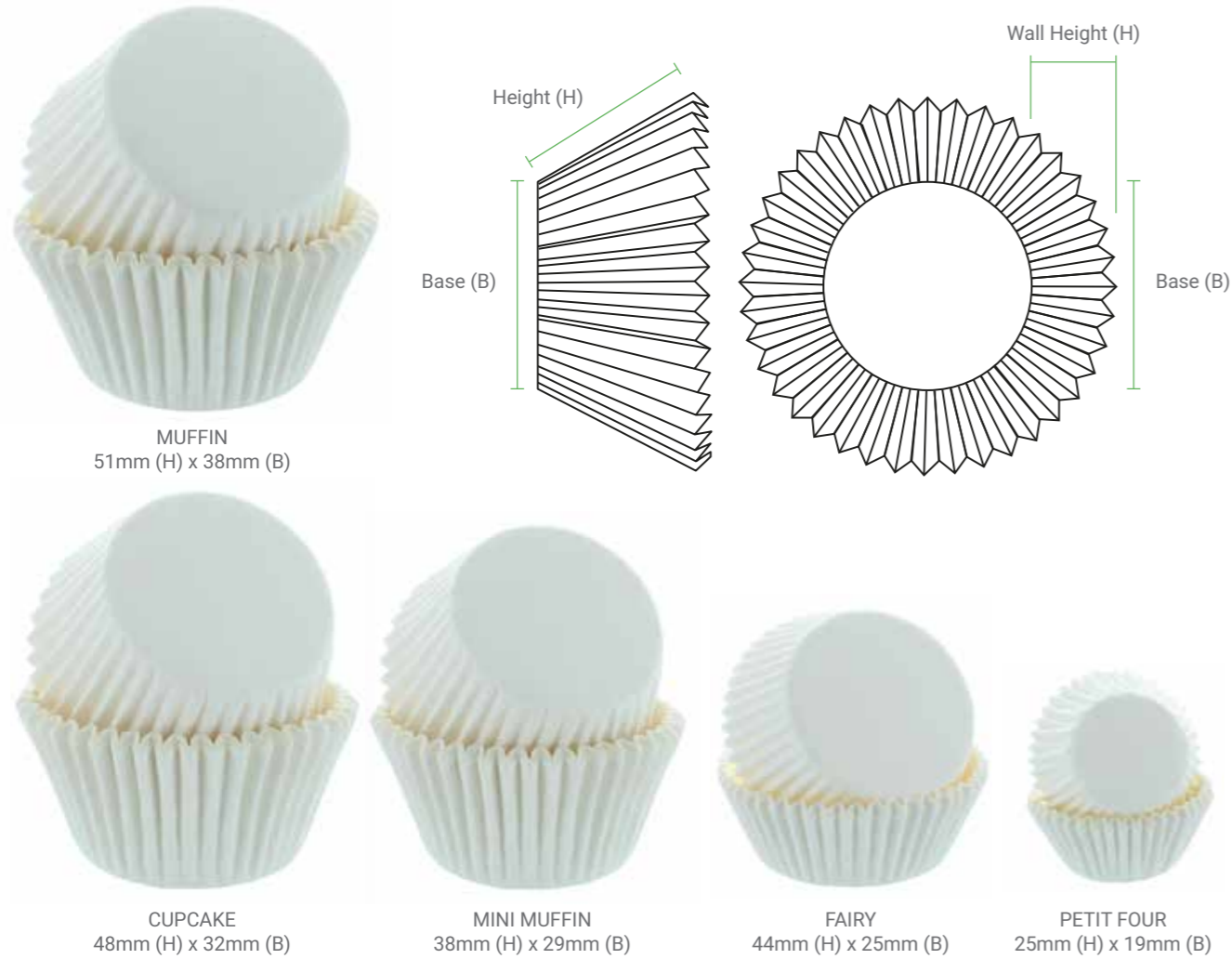

What's possible?

- ✓ **Wide range of sizes available**
- ✓ **Bespoke tooling for custom sizes**
- ✓ **Printed greaseproof**
- ✓ **All over patterned designs**
- ✓ **Registered designs**
- ✓ **Spot colours matched to pantones**
- ✓ **CMYK print**
- ✓ **Greaseproof lined foils**
- ✓ **Patisserie supplies including tulip wraps, eclair cases and tart cases**



Bespoke Design & Print Cases



Looking for something special to make you stand out from the competition? You can provide your own bespoke artwork, or our in-house design service can help create your baking case just how you want it. The manufacturing method is determined by the combination of design and print types, or vice versa.

There are three types of possible designs.



SINGLE COLOUR

Plain case that is printed in one-colour on the outside. Single colour designs can also be foil.



RANDOM PATTERN

Simple, all over patterns that do not specifically line up with the base or wall of the case. Pattern appears randomly all over the outside of the case.



REGISTERED

Design elements are specifically positioned on the case, for example when a logo is lined up on the base, or there's a fixed pattern around the wall.

Designs are printed in one of two ways:

Spot Colour Printing

Uses an individual ink for every colour and printing each one separately. It is generally limited single colour, or simple designs with just a couple of colours to keep the costs low.

CMYK Printing

Also known as process printing or 4 colour printing uses only four colours: cyan, magenta, yellow and black. These are mixed to create infinite colours and shades in one design. More complex designs or photorealistic images can be produced using CMYK printing.



Choose from stock colours and patterns in the core sizes for the cheapest options and lowest MOQs, or talk to us about bespoke sizes and designs.

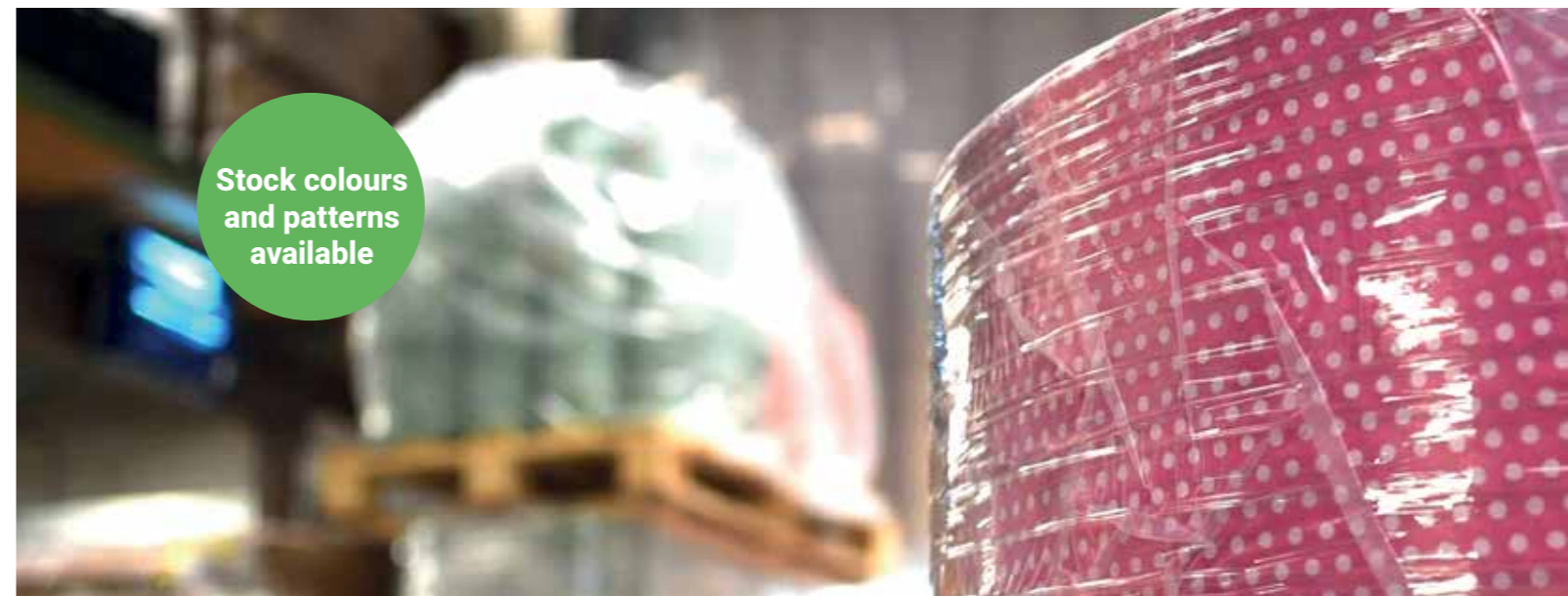
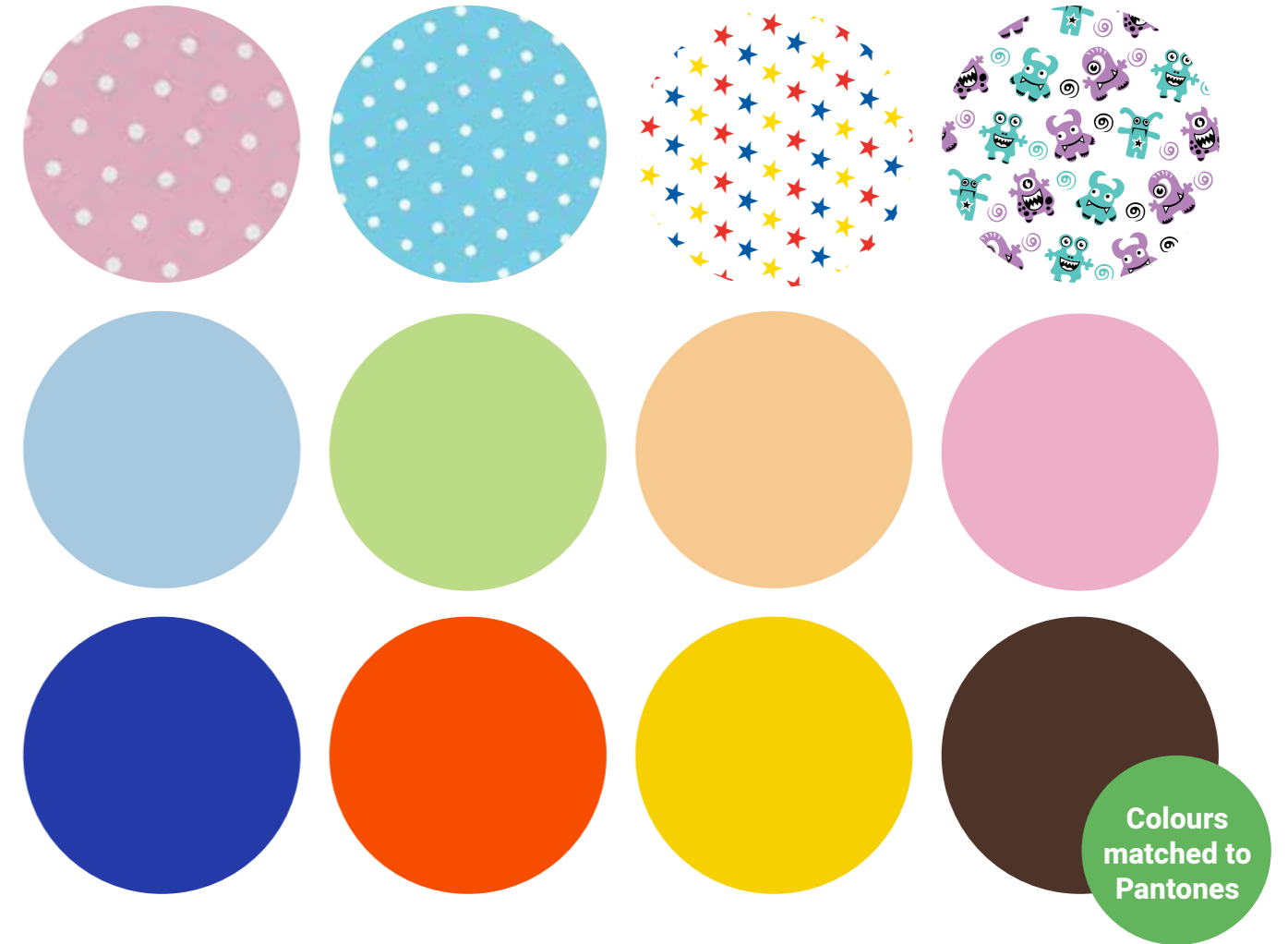

Liners



Our exceptionally versatile greaseproof and siliconised liners are available in round, oval, square or loaf tin shapes in a wide range of industry standard sizes. Suitable for baking, cooking, air frying and freezing, they can be used for anything from fondant fancies and flans, to fried chicken. Custom tooling is also possible for bespoke sizes.

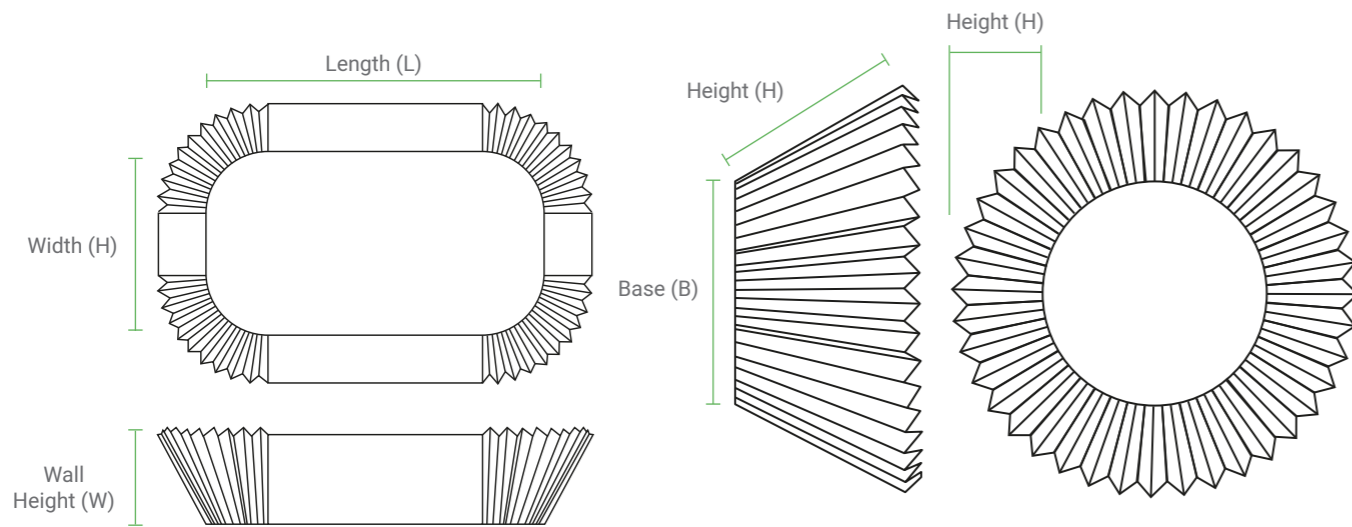

Sizes from 41mm to 190mm base available

Sizes from 89mm to 242mm base available



Sweet or savoury

What's possible?

- ✓ Wide range of standard sizes
- ✓ Bespoke tooling for custom sizes
- ✓ Round, oval, square and rectangle
- ✓ White or brown greaseproof
- ✓ White or brown siliconised greaseproof
- ✓ Printed greaseproof
- ✓ All over patterned designs
- ✓ Registered designs
- ✓ Spot colours matched to pantones



Non-stick

Available in white and brown



DORIC FPD

- CAKE BOARDS
- CAKE DRUMS
- CAKE CARDS
- CAKE BOXES
- GREASEPROOF PAPER
- CARD PACKAGING

Doric FPD specialises in the manufacture of cake boards and innovative customised food packaging to meet industrial food production and consumer needs.

Our diverse capability covers cake boards and cards, as well as packaging components for hot and cold food including greaseproof paper liner sheets and folded box board items such as U-cards, base cards, cake collars, takeaway box lids, card trays, box inserts and much more.

Our die cutting process is fast and highly cost efficient, meaning our customers can rely on FPD quality time after time to protect, pack and present sweet and savoury produce, on time and on budget.

Talk to us about your specific packaging brief today. No one size fits all, so we'll work with you to find the best material and construction for your finished goods.



CAKE BOARDS & CARDS



GREASEPROOF PAPER



U-CARDS



CAKE COLLARS



BASE CARDS



TAKEAWAY BOX LIDS



The mark of responsible forestry

Proud to be a **Sedex** Member

Doric FPD, Farrington Road, Rossendale Road Industrial Estate, Burnley, Lancashire, BB11 5SW
 T: +44 (0)1282 423 142 E: info@doricfpd.co.uk
 www.doricfpd.co.uk
 Company Number: 6956605 VAT: 979339356 EORI: GB979339356000

Cake Boards & Cake Cards



Our UK manufactured cake boards and cards are produced to an exceptional standard. We pride ourselves in the highest quality and depth of range supplying shapes and sizes from 4" to 24". We use a combination of machine precision automation and highly skilled hand finishing to deliver the best boards at the best prices.



4" to 24" plus custom sizes available



TURNED EDGE CAKE BOARDS

A board that is covered on the top and sides is called a 'turned edge' board. This type of finish gives the most premium presentation at an affordable price. They are generally used for larger, heavier celebration cakes. Delivering quality is at the heart of our UK operations because special occasions deserve the best boards!



CUT EDGE CAKE CARDS

Commonly cut directly from PE coated or foil backed card, a 'cut edge' board has a raw edge. They are used as a base for lighter cakes and in consumer-packaged cakes. Highly cost-effective, disposable cut edge options are ideal for FMCG and volume production.

What's possible?

- ✓ Industry standard sizes and shapes
- ✓ Bespoke tooling for custom sizes and shapes
- ✓ Cut edge cards from 1.1mm to 3mm
- ✓ Turned edge cards and boards from 1.6mm to 12mm
- ✓ Silver, coloured or patterned foils
- ✓ Folded or banded edges



Choose your size, shape and colour



Bespoke Food Packaging



Our extensive capability means we'll work with you to understand your specific food product and processes so you can be sure the packaging is fit for purpose, whatever that might be. Our packaging solutions help protect, present and transport food through production to distribution and consumption. We create solutions for dividing, inserting or wrapping all hot and cold sweets and savouries. We use substrates suitable for cooking, baking, air frying, microwaving and freezing to help make sure your food product reaches the consumer in the best quality condition.



Reliable protection for food



What's possible?

- ✓ Bespoke tooling for custom sizes and shapes
- ✓ Machine precision die cutting
- ✓ Folding box board
- ✓ Corrugated board
- ✓ Greaseproof paper liner sheets
- ✓ Siliconised greaseproof paper sheets
- ✓ Greyboard with aluminium foil/metalised film/PE coating
- ✓ Recycled greyboard
- ✓ White PE 1 or 2 sided
- ✓ Kraft paper
- ✓ Wax coated Kraft paper
- ✓ PP sheets
- ✓ Apet sheets



Custom solutions for packaging food





Not sure your volumes justify a bespoke production brief?

Culpitt supplies a huge range of wholesale items that might be just right for you.

We stock our UK manufactured decorations and packaging in pack sizes to suit smaller business needs. Choose from all the most popular sizes of cake boards, cake boxes, tin liners and baking cases and explore cake decorations to suit all budgets at www.culpitt.com

Culpitt is the UK's leading wholesaler of cake and cupcake decorations and supplies. We can supply you quickly, efficiently and at great prices.

We offer great benefits when you open an account:

- Save £££ by buying direct from the manufacturer
- No minimum spend
- The more you spend, the better your prices will be
- Spend just £95 to get **FREE UK delivery** on your order

It's **FREE** and simple to open an account online and you'll be able to view prices instantly.



SPEND JUST £95 TO QUALIFY FOR FREE UK DELIVERY



FREE & NEXT DAY DELIVERY



EASY ONLINE ORDERING



NO MINIMUM ORDER



DEDICATED CUSTOMER SERVICES



www.culpitt.com

Jubilee Industrial Estate, Ashington NE63 8UQ

Browse the full range at www.culpitt.com. Call **01670 814 545** for details.

Bestsellers



Drums

Wide range of sizes, shapes and colours



Cards

Wide range of sizes and thickness



50595

Culpitt Select Kraft Brown Baking Cases



19P-101

Loaf Tin Liners



SMC020

Sweetmelt® Carrot



50549

Birthday Baking Cases



SUG910

Sweet Talk Sugarettes



SUG756EF

Pink Five Petal Flower



SUG651

Gold Lustre Sugar Star



SUG929

Jolly Gingerbread Sugar Plaques



CL6008

Christmas Triple Holly



SUG660EF

Unicorn Horns

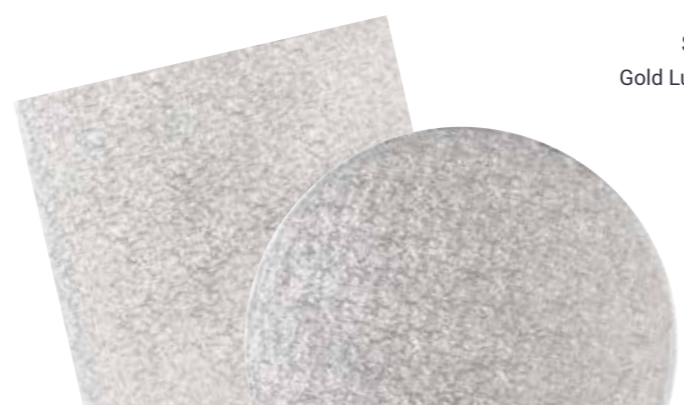

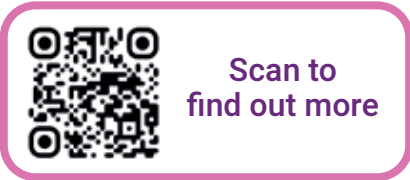

Sugarfayre Limited, Unit 2 Wansbeck Business Centre, Rotary Parkway, Ashington, Northumberland, NE63 8QW
 T: +44 (0)1670 814 545 E: sales@sugarfayre.net
 www.sugarfayre.net
 Company Number: 02656629 VAT: 556 1355 41 EORI: GB556135541000



Doric Crimped, Bowden Park, Chapel-en-le-Frith, High Peak, Derbyshire, SK23 0JX
 T: +44 (0)1298 812 181 E: info@doriccrimped.co.uk
 www.doriccrimped.co.uk
 Company Number: 7404814 VAT: 104906632 EORI: GB104906632000



Doric FPD, Farrington Road, Rossendale Road Industrial Estate, Burnley, Lancashire, BB11 5SW
 T: +44 (0)1282 423 142 E: info@doricfpd.co.uk
 www.doricfpd.co.uk
 Company Number: 6956605 VAT: 979339356 EORI: GB979339356000



Jubilee Industrial Estate, Ashington NE63 8UQ
 T: +44 (0)1670 814 545 E: info@culpitt.com
 www.culpitt.com
 Company Number: 00261326 VAT: 0022910534 EORI: GB 229105384000

